

INSTRUCTION MANUAL

CLAM PRO



CE

S.E.F.A[®]
Z.I PASTABRAC
11260 ESPERAZA
FRANCE

Tel : +33 (0)4.68.74.05.89 - Fax : +33 (0)4.68.74.24.08

E-mail : contact@sefa.fr

INDEX

I.	CONDITIONS OF GUARANTEE	3
II.	SPECIFICATIONS.....	4
III.	PARTS SUBJECTED TO WEAR AND TEAR	4
IV.	USING THE PRESS	5
A.	INSTALLATION.....	6
1.	Unpacking.....	6
2.	Choosing the working direction with the reversible lower plate	6
B.	DESCRIPTION OF THE OPERATING CYCLE.....	6
C.	USING « DRY » MODE (Optionnal)	6
D.	CONTROL PANEL : OVERVIEW	7
E.	USING THE CONTROL PANEL	7
1.	Pressing time and temperature settings	7
2.	Preheating cycle	8
3.	Stop Cycle.....	8
4.	Recording programmed cycles	8
5.	Selection of programmed cycle	9
6.	Parts counter	9
7.	Warnings	9
8.	Power save function.....	10
F.	PRESSURE ADJUSTMENT	10
G.	MAINTENANCE	10
V.	QUICK REPAIR ADVICES	11
VI.	ELECTRIC DIAGRAM	12
VII.	MAINTENANCE LOG	13

I. CONDITIONS OF GUARANTEE

- The guarantee period starts the day of putting the equipment into service at the user's place, materialized by the return of the guarantee bill for a duration of two years, 8h per day meaning about 3000 hours.
- The guarantee is strictly limited to our equipment, against the defects of matter and execution, with the buyer's responsibility to prove the known defects.
- Our responsibility is limited to the obligation to rectify or replace free of charge the parts acknowledged as faulty by ourselves, and there will no claim for any indemnity whatever the reason given.
- Parts replaced under the guarantee:
 - remain our property
 - are the subject of an invoicing of deposit
- A credit of cancellation is activated as soon as the faulty parts are returned. The return will have to occur ONE MONTH MAXIMUM after the intervention

THE GUARANTEE DOES NOT COVER:

- The retail consumables such as:
 - Fuses, bulbs, joints, flexible devices, covers, nozzles, filters.....
 - The supplies, which are not our own manufacturing, undergo the guarantee of their manufacturer.

THE GUARANTEE DOES NOT APPLY:

- To replacements, nor repairs which would result from normal wear and tear of apparatus and machines, of deteriorations and accidents coming from negligence, defect of monitoring and maintenance, defective use or modifications without our written agreement.
- In case of vice coming from the material supplied by the buyer, or a design imposed by the latter.
- To repairs which would result from deteriorations or accidents occurred during transport.
- To operations of maintenance and adjustments inherent in the use of the machine, and indicated in the maintenance manual, such as:
 - Adjustments of intermediaries
 - Screwing of piping, etc...



For the pneumatic machines, any trace of detergent oil in the pneumatic circuit inhibits the conditions of guarantee previously mentioned.

**For any technical information or spare parts orders,
please give the reference number of the machine as well as its serial number**

II. SPECIFICATIONS

	CLAM PRO
Weight in running order	57kg
Height (opened)	969 mm
Depth	830 mm
Width	439 mm
Dimension of the heating plate	400 x 500 mm
Electric power supply	230 V single phase + ground 50/60 Hz
Power	2500 W
Amperage	11 A
Thermoregulator	
Accurate to	+/- 1%
Range of control	0 à 220 °C
Timer	
Accurate to	+/- 1%
Range of control	0s to 9min30s
Adjustable pressure	0 to 450 gr/cm ²

Non contractual document: according to the technical progress, we reserve the right to modify the characteristics of our products..

III. PARTS SUBJECTED TO WEAR AND TEAR

For any order: precise the description, the reference and the quantity

Référence	Description	Quantité
CAR-CO2	ELECTRONIC CARD	1
REL-OM5	HEAT RELAY	1
RES-546	HEAT ELEMENT MICA 400x450 2500W for CLAM PRO	1
SON-189	SENSOR	1
FIN-231	MICROSWITCH WITH TONGLE	1
MOU-540	SILICONE RUBBER 400x500 mm	1
RES-BI1	GAS SPRING	1
VEN-300	ELECTROMAGNET 230V 7W	1
FUS-150	FUSE 16 A	1

IV. USING THE PRESS

This press thermal paste has been designed to make a small batch production while respecting labour laws, to ensure the safety of the user.

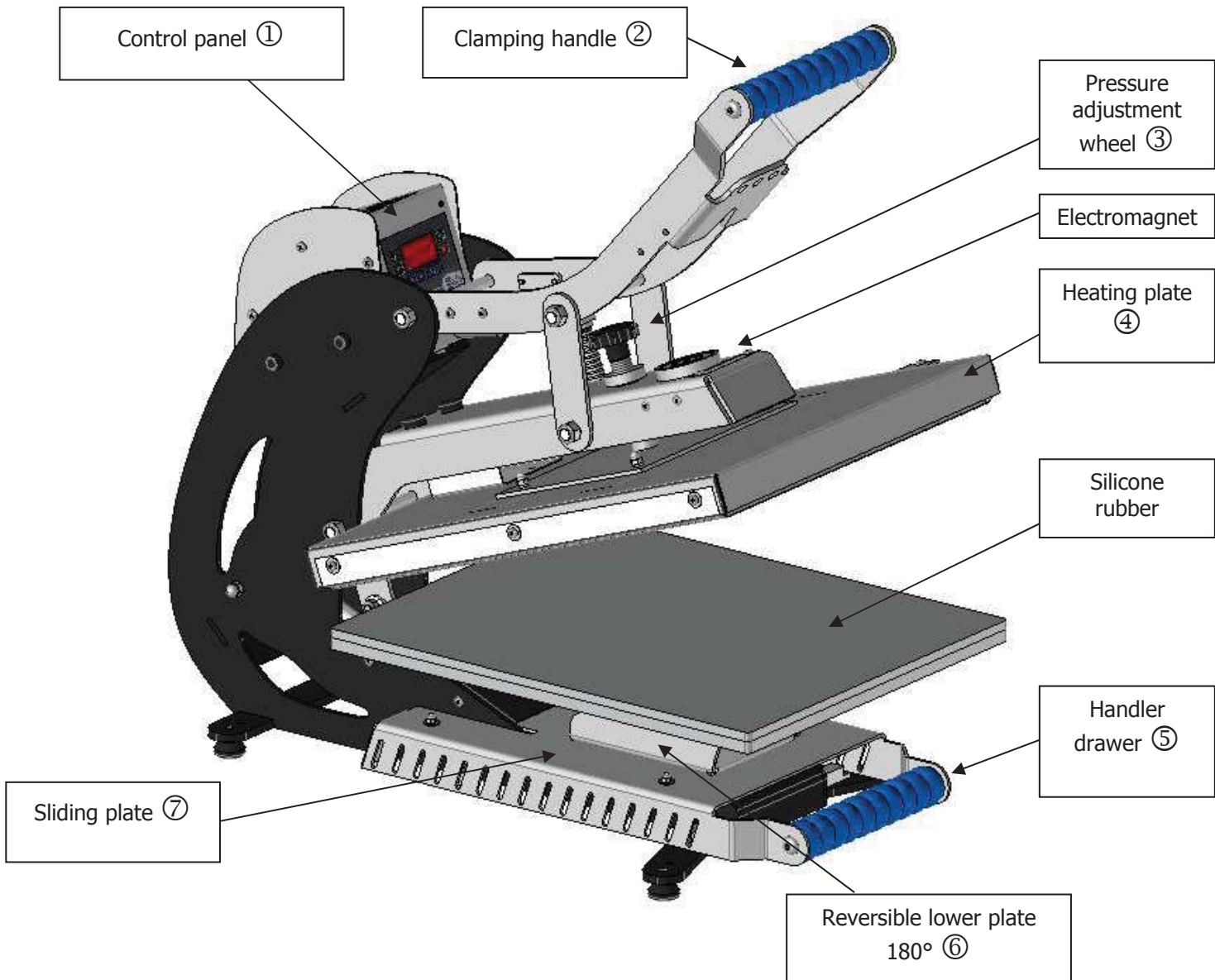

This press was designed for an operator working in front of the machine.

A. INSTALLATION

1. Unpacking

1. Remove the press from its packaging.
2. Place the machine on its operating location.
3. For carrying the press, ensure that the press is cold and move the press by holding the two plates (top and bottom) at the same time (closed press).
4. Remove the screw labelled « Transport security » before opening the press.
5. Plug the machine electrically (230 Volt + Ground / 50 or 60 Hertz)

2. Choosing the working direction with the reversible lower plate

This press is equipped as standard with a reversible lower plate (180 °), allowing you to put the T-shirt either from the front or the back of the plate.

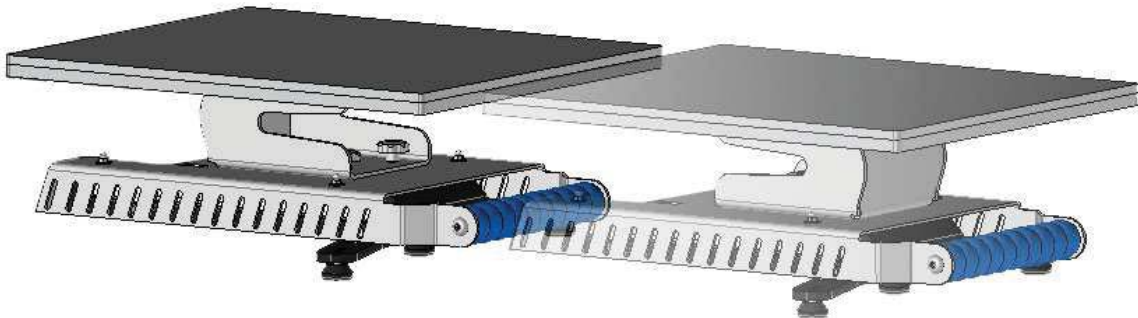

To reverse the direction of the support (See number ⑥ page **Erreur ! Signet non défini.**) :

1. Unscrew the 2 wheels between the support and the lower plate,
2. Reverse the support,
3. Screw the 2 wheels under the lower plate.

B. DESCRIPTION OF THE OPERATING CYCLE

1. Power on the press by pressing the power switch located at the rear.
2. Adjust set point temperature See § E.1.b).
3. Adjust pressing time See § E.1.a).
4. If desired, set the preheating time See § F
5. Adjust the pressure (according to the type of transfer) See § F.
6. Put the T-shirt on the lower plate.
7. Adjust the transfer sheet.
8. Lower the heating plate using the handle (once the plate has reached the desired temperature).
9. When the plate is in contact with the T-shirt, the timer starts.
10. At the end of the countdown, the press will open automatically.
11. If you want to interrupt the cycle, you can do it by pushing the stop button located on the control panel: the press will open automatically within 2 seconds. Voir § E.3
12. User the handle (See number ⑥ page 5) to slide the lower plate.

C. USING « DRY » MODE (Optionnal)

Optionally, the press is available with the « DRY » function, which ensure a contactless approach for direct printing drying.

1. Adjust set point temperature See § E.1.b).
2. Adjust drying time (See § C - Same procedure as for the pressing time).
3. Put the T-shirt on the lower plate.
4. Once the plate has reached the desired temperature, gently lower the heating plate using the handle until the first gush: the heating plate is locked to the lower plate, but without contact.
5. When the plate is locked, the timer starts.
6. At the end of the countdown, the press will open automatically.

D. CONTROL PANEL : OVERVIEW

(See number ① page 5)

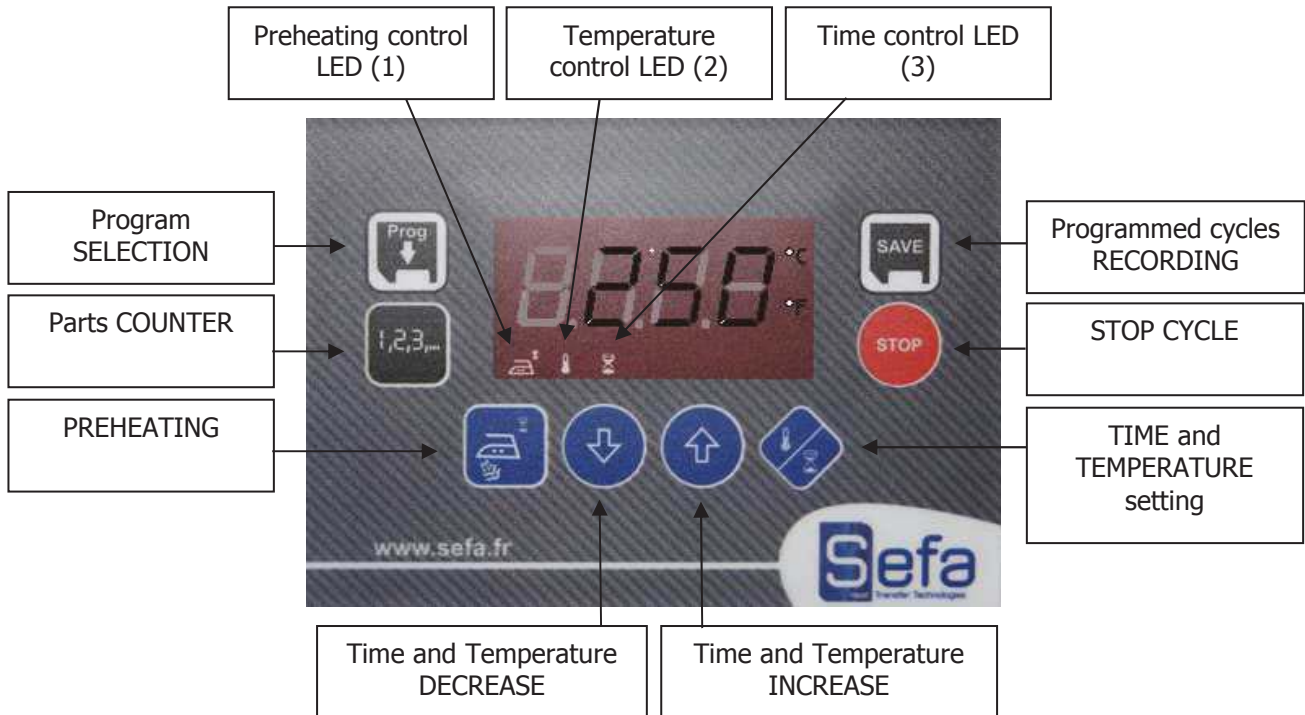



E. USING THE CONTROL PANEL

1. Pressing time and temperature settings



a) Pressing time

Press TIME/TEMPERATURE key  : the LED ③ lights and indicates that you can set the pressing time. The default value is set to 15 seconds.

You can change this value with the INCREASE key  or the DECREASE  key. Confirm

Confirm the desired value by pressing again on the TIME/TEMPERATURE  key. Now, you can adjust the set point temperature.

b) Temperature

After setting the pressing time, the LED ② lights and indicates that you can adjust the set point temperature. The default value is set to 180° C.

You can change this value by pressing the INCREASE  key or the DECREASE  key.

Confirm the desired value by pressing again on the TIME/TEMPERATURE  key. Now, the press is ready to work.

2. Preheating cycle



The press is provided with a secondary timer for preheating.
This function allows you preheat the textile before installing the transfer.

a) Preheating time setting

Pressing PREHEATING  key, The LED ① lights.

You can change the value with the INCREASE  key or the DECREASE  key.

Confirm the value by pressing again on the PREHEATING  key.

If the value is 0 (default value), the preheating cycle will not be performed.

b) Running

Install the textile without transfer on the plate.

Lower the heating plate : the secondary counter starts and the LED ① lights.
At the end of the countdown, the buzzer rings and the press open automatically.

Install the transfer on the textile and lower the heating plate.

The main counter starts and the LED ③ lights.
At the end of the countdown, the press open automatically.

Nota : the preheating temperature is the same as the set point temperature.

3. Stop Cycle

At any time, you can stop the cycle by pressing the STOP CYCLE  key.
The press open automatically and the countdown stops.

4. Recording programmed cycles



You can record on this press up to 3 programs with different set points.

- Preheating time
- Pressing time
- Temperature

For recording the last set points used, press the RECORDING  key.
The display lights up with the program name to be recorded (First Pr1).

Choose the program name you want to be recorded by successive pressures on RECORDING  key : Pr1 → Pr2 → Pr3 → Pr1...

Press during 3 seconds on the RECORDING  key to save the program.

The default value for the 3 programs Pr1 to Pr3 is :

- 180° C. for the temperature
- 15 seconds for the pressing time
- 0 second for the preheating time

5. Selection of programmed cycle



To select a recorded program, press on the SELECTION  key : the screen displays the last program used. Press the key until the display of the desired program.

Keep the SELECTION  key pressed while 3 seconds to confirm your selection. The buzzer sound indicates the selection success. The temperature set point, the preheating time and the pressing time according to the selected program will be loaded automatically.

6. Parts counter



The press has 2 parts counters :

- An erasable counter, with a possible reset
- A main counter, without reset.

a) Erasable counter

Press one time on COUNTER  key : the screen displays during 5 seconds the number of cycles performed with success since the last reset.

A pressure of 3 seconds will reset the counter.

b) General counter

Press 2 time on COUNTER  key : the screen displays the total number of cycles performed, into hundreds of pressing (Example : 230 indicates 23000 parts). Reset is not possible.

After 3 seconds, the screen returns to the normal display.

7. Warnings

Message on the screen	Due to	Effect
Er1	Temperature probe default	Heating relay off
Err	Card probe default	Heating relay off
Col	Keyboard connection alarm	Relay off

Each alarm is accompanied by the activation of the buzzer, which can be stopped by pressing any key.

8. Power save function



This function can only be programmed by qualified staff: contact your dealer

The press has an energy-saving program, allowing to maintain a set point temperature after a defined time without use.

The default value is « disabled ».

Contact your dealer for the activation of this function.

F. PRESSURE ADJUSTMENT

The pressure is obtained by approaching the upper/hot plate to the lower/cold plate.

1. Unscrew the pressure adjustment wheel. (See number ③ page 5)
2. Turn the wheel on the top of the heating plate :
 - clockwise to increase the pressure,
 - anticlockwise to decrease it.
3. Screw the nut back to lock and secure the system.

G. MAINTENANCE

- Every day:
 - ↳ Clean the heating plate with a dry cloth. (See number ④ page 5)
- Depending on use:
 - ↳ Change the silicon rubber as soon as it is damaged or if it has lost its properties.

V. QUICK REPAIR ADVICES



All repair and maintenance operations should be done when the machine is turned off and unplugged from the main electric power supply. The heating element can cause burns. The user must ensure the temperature is below 25°C on the display, before any intervention.

<u>SYMPTOMS</u>	<u>POSSIBLE BRAKDOWNNS</u>	<u>REPAIRS</u>
The plate will not heat	<ul style="list-style-type: none"> ➤ One of the fuses is out of order ➤ The relay is damaged ➤ Sensor out of order and/or regulator displays ER1 	<ul style="list-style-type: none"> ➤ If no light when the press goes on, check the fuse, change it if necessary. GENERAL FUSE located in a seating next to the plug of the power supply cable (16 A). To access it, pull the electrical cable off with the tip of a pen or a screwdriver, lift the fuse seating. You will find in a square tube a spare fuse to replace the one in the clip. ➤ Check it out and change it if necessary ➤ Change the sensor
The plate overheats	<ul style="list-style-type: none"> ➤ The relay is stuck ➤ The card is damaged 	<ul style="list-style-type: none"> ➤ Change the relay. ➤ Change the card
The timer doesn't start	<ul style="list-style-type: none"> ➤ The microswitch isn't activated 	<ul style="list-style-type: none"> ➤ Make sure the microswitch tongue is touched by the pressing arm of the machine.
The buzzer rings continuously while the press is opened	<ul style="list-style-type: none"> ➤ The microswitch is incorrectly set 	<ul style="list-style-type: none"> ➤ Check the position of the microswitch or change it.
The press doesn't stay closed	<ul style="list-style-type: none"> ➤ The microswitch is stuck ➤ The electromagnet is not activated or it is out of order 	<ul style="list-style-type: none"> ➤ Release the microswitch tongue or change it. ➤ Check the wires.

VI. ELECTRIC DIAGRAM

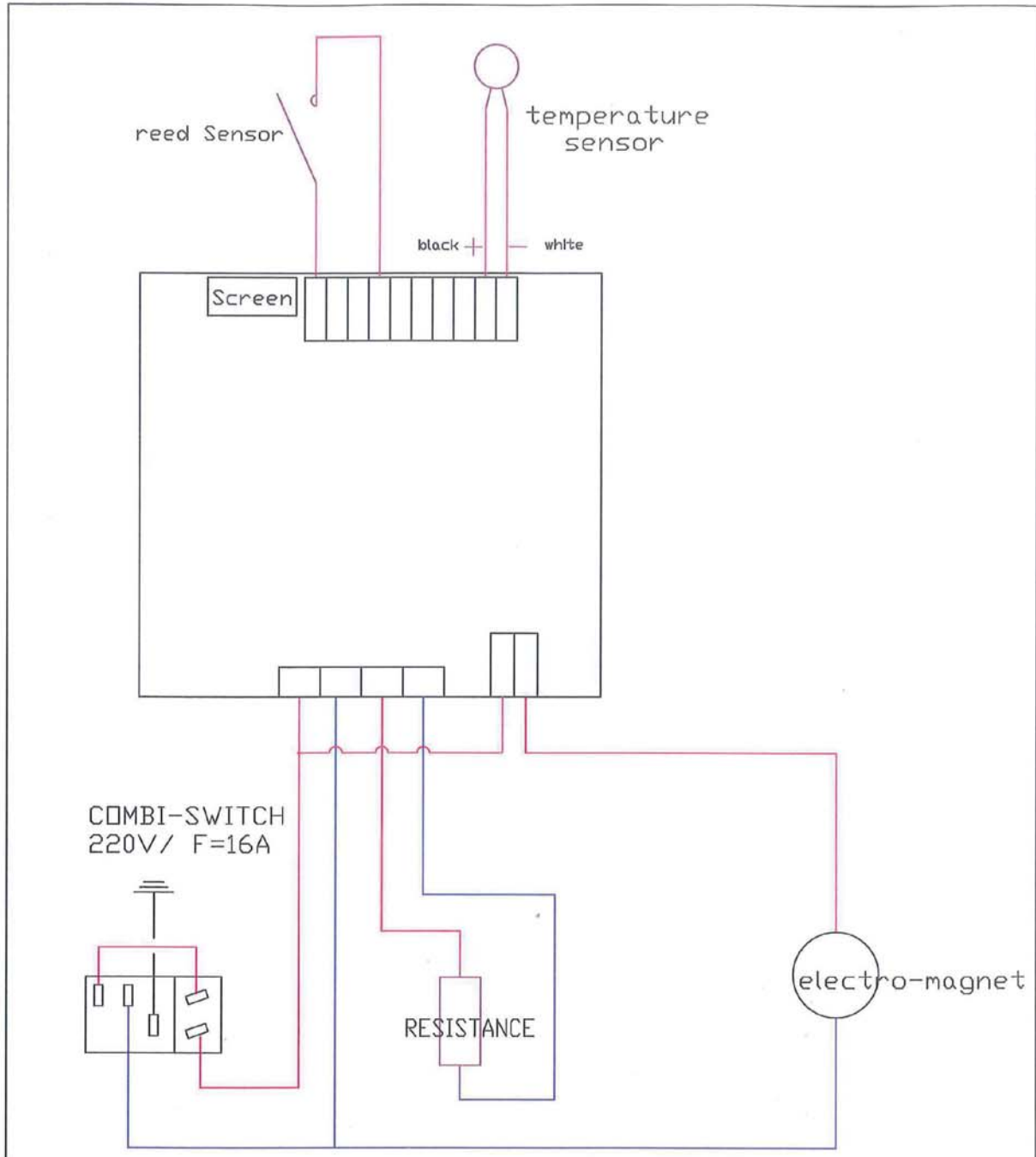

S.E.F.A.		ZI PASTABRAC 11260 ESPERAZA		Nbre/ENSEMBLE: 1			
		TEL: 04 68 74 05 89 FAX: 04 68 74 24 08		DIM: -			
Electric Diagram				Mat:	Epi:		
				FAIT LE: 8/01/13			
				MODIF LE: -			
				N DU PLAN:	Mod:		
ENSEMBLE		CLAM PRO		-	A		

VII. MAINTENANCE LOG

The control and maintenance operations indicated in this table must be done regularly so as to check the functioning state and the reliability of the press.

Date	Number of hours	Pressure control	Air filter control	Air Cylinder control	Rubber state	Resistors control	Changed parts	Observations

In order to facilitate the filling of the table, it may be useful to use the following code:
 C: Control N: Clean R: Replace